

TECHNICAL SPECIFICATIONS

FEATURES

- 10-100% brightness range dimming
- Pre-adjustment setting
- Tough impact-resistant thermoplastic housing
- Smooth action slide control
- Long mounting strap for increased wall board contact

SPECIFICATIONS

- | | |
|----------------------------|-------------|
| • Dimmer type : | LED dimmer |
| • Voltage : | 120V |
| • Capacity : | 150W |
| • 3 Way : | Yes |
| • Operating temperature : | 0°C to 40°C |
| • Face and Body material : | PC |
| • Applicable standard : | UL1472 |
| • Warranty : | 1 Year |

PRODUCT NUMBER

LCDIM-LED150W-CFL



DIMMING RANGE ADJUSTMENT

- Turn dimmer on and move slider down to the bottom
- Turn knob down until lowest light level is achieved and light output is stable for all bulbs
- Turn dimmer off, then back on to verify bulbs
- Turn knob up lightly and do step 3 again if all bulbs do not turn on
- Once all bulbs are dimming properly, install faceplate

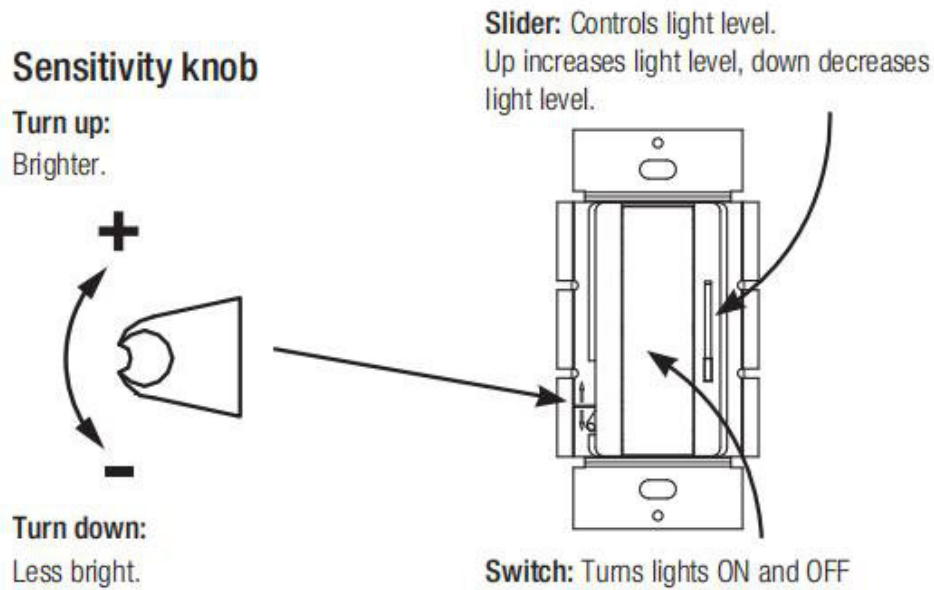

IMPORTANT: Set slider to bottom before adjusting dimming range. When the slider is at the top, the sensitivity dial will be out of operation.

DIAGRAM

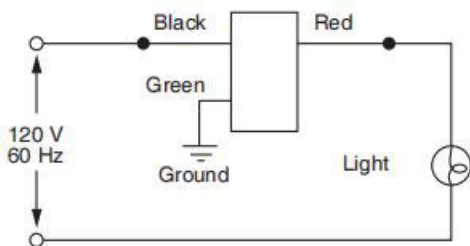

Single-pole wiring

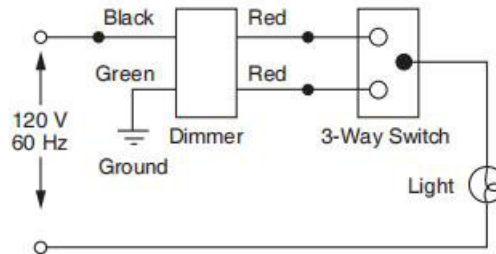

3-way wiring

MULTIGANG INSTALLATIONS

In multi-dimmer installations, the capacity of dimmer is different. Refer to the below chart.

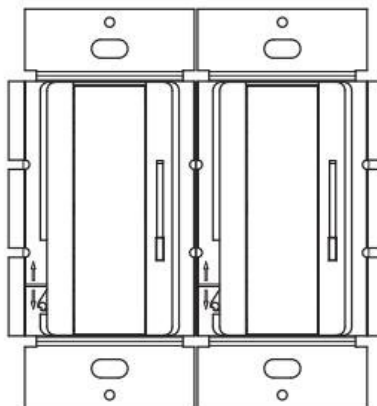

Each Control Has Inside Sections Removed

Only INCANDESCENT Dimmer Rating:

Cat. No.	Single-Gang Rating	Double-Gang Rating	Triple-Gang Rating
Slide/Decorator	600 W	500 W, 500 W	400 W, 400 W, 400 W

INSTALLATION

1. Turning power OFF.

- Turn power OFF.

2. Wiring the Dimmer.

Single-pole Wiring

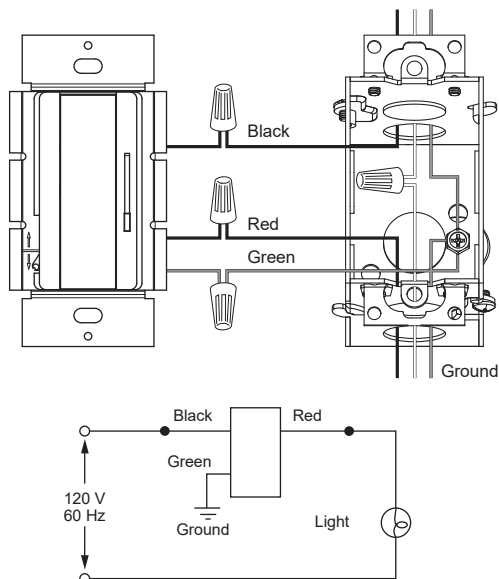

3-Way Wiring

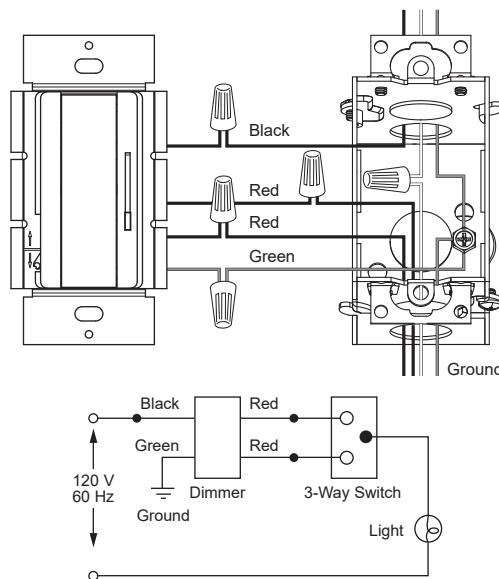

3. Mounting dimmer to wallbox.

Push wires carefully into the wallbox, Install wallplate.

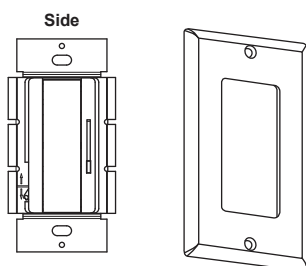

4. Turning power ON.

Turn power ON.

CAUTION - To Reduce The Risk of Overheating and Possible Damage to Other Equipment, Do Not Install to Control a Receptacle, a Motor-Operated Appliance or a Fluorescent Lighting Fixture or a Transformer Supplied Appliance.

ATTENTION - Pour réduire le risque de surchauffe et les possibles dommages à d'autres équipements, ne pas installer pour contrôler un réceptacle, un appareil à moteur ou un luminaire fluorescent ou un appareil fourni par transformateur.

WARRENTY INFORMATION

If within one(1) year from the date of purchase, this product fails due to a defect in material or workmanship, we will repair or replace it, at its sole option, free of chare. This warranty does not apply to: (a) damae to units caused by accident, droppine or abuse in handline, acts of God or any neelient use; (b) units which have been subject to unauthorized repair, opened, taken apart or otherwise modified; (c) unit not used in accordance with instructions; (d) damaes exceedine the cost of the products. This warranty service is available by returnine the products with proof of purchase date and a description of the problem to dealer from whom the unit was purchase.