



PERFECT FOR INDOOR OR OUTDOOR USE









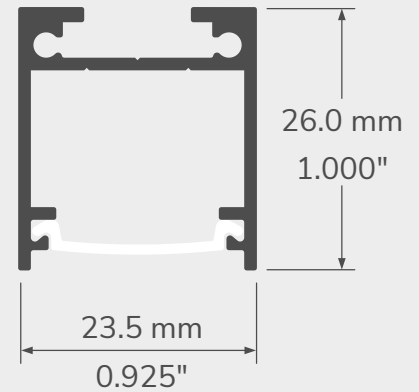









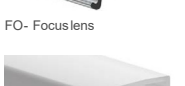

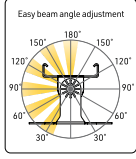



This profile is the biggest in size from our 100 series line of product. It has been specially designed for outdoor use and can house all the different IP68 lumen Packages we offer. With a new sliding lens design, this profile offers a wide variety of installation, from fixed to suspended mounting.

FEATURES

- The support rail offers a large range of installation and assembly both fixed and suspended.
- NEWslidable lens system.
- Designed to give a uniform light without hot spots with a prime lens.
- Custom length by sections of 2 to 240 inches (6m).
- Made of ALCOA 6063-T5 aluminum alloy increasing heat dissipation.
- Its use increases the lifetime of your LED engine.
- Designed to meet North American woodworking standards.

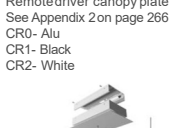
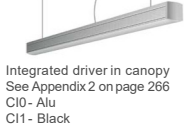
TECHNICAL DRAWING

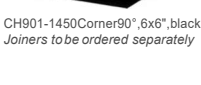

| PROFILES | LENSES | MOUNTING HARDWARE | SUSPENSION / RECESS | REFLECTOR | LENGTH |
|--|--|--|--|---|---|
|  <p>145 - Series alu</p>  <p>145BK - black</p>  <p>145WH - white</p>  <p>145CS - custom color</p> |  <p>PR- Prime lens</p>  <p>OP- Opal lens</p>  <p>BK- Black lens</p>  <p>FO- Focus lens</p>  <p>PR3D- Square 3D, Prime</p> |  <p>SW- Swivel bracket 180°</p>  <p>Easy beam angle adjustment</p>  <p>HDSW- Heavy duty swivel bracket</p>  <p>PH- Phantom bracket</p>  <p>MG- Magnetic kit</p>  <p>WSB- Surface 2-side bracket</p>  <p>SWS- Surface 1-side bracket</p>  <p>AWS- Surface 90° bracket</p>  <p>W45- Surface 45° bracket</p>  <p>SUS- 1400 suspension kit</p> | <p>NOTE: Canopies only available with SUS bracket (suspension)</p>  <p>Remoted driver canopy plate See Appendix 2 on page 266 CR0- Alu CR1- Black CR2- White</p>  <p>Integrated driver in canopy See Appendix 2 on page 266 CI0- Alu CI1- Black CI2- White</p>  <p>Integrated driver & suspension kit See Appendix 2 on page 266 CIK0- Alu CIK1- Black CIK2- White</p> <p>NOTE: Can be used with PH bracket (phantom) or flat head screw</p>  <p>Gypsum groove 1/2", 4" See page 194 for details G1450</p> |  <p>HER- High efficiency reflector</p> | <p>Custom length by sections of 2 to 240 inches (6m).</p> |
| <p>RAL NUMBER</p>  <p>CH900-1450 corner 90°, 6x6", alu. Joiners to be ordered separately</p>  <p>CH901-1450 Corner 90°, 6x6", black Joiners to be ordered separately</p>  <p>JS- Type B straight joiner</p> | | | | | |

