

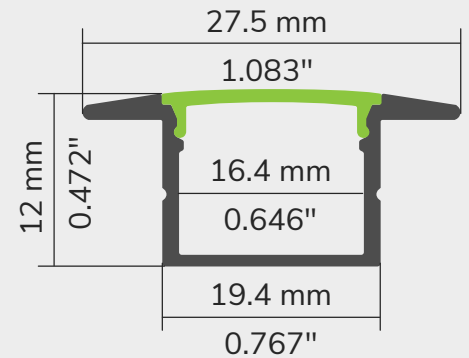

TECHNICAL DRAWING











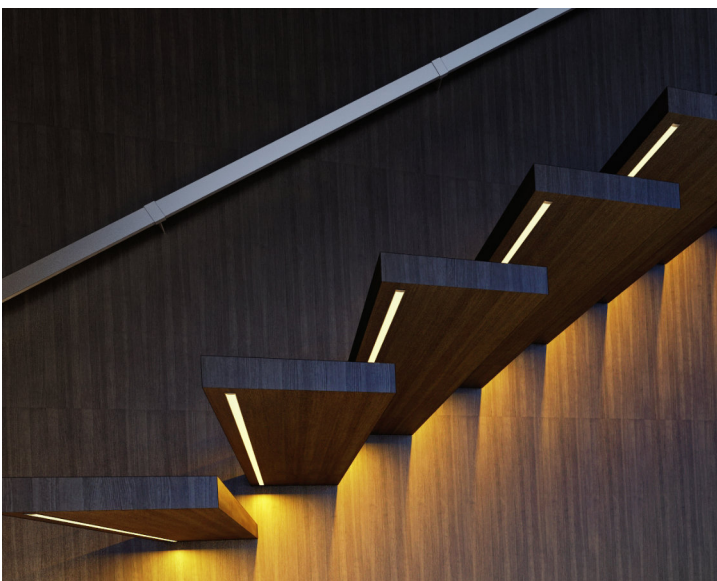

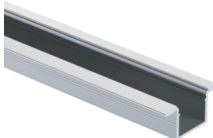
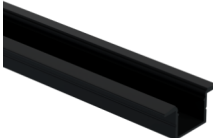
AN EXAMPLE OF INTEGRATION INTO YOUR DECOR

This recessed profile is designed to make the light source invisible. Its compact form factor permits a wide range of use. Made of 6063T-5 aluminum, our LED extrusions can be installed both indoors and outdoors. They can be painted to match your decor. Available in 8 and 16 feet lengths to suit all your spaces. Our 86 series aluminum profile can accommodate a variety of white and colored (RGB-RGBW) LED strips.

FEATURES

- Designed for recessed installation.
- Available in 8 and 16 foot lengths.
- Custom fabrication up to 192 inches.
- Accommodates and protects the majority of our LED strips.
- Certified for the Canadian market.



COLOR				
	AL - Aluminum - Plain	BK - Aluminum - Black	WH - Aluminum - White	CU - Aluminum - Custom
LENS				
	OP - Opaque	BK - Black		
MOUNTING				
	ST - Standard	SW - Swivel		
ENDCAP				
	NH - No hole	WH - With hole	PA - For one of each	

FILL TO ORDER

LC	PROF	-	86	-		-	OP	-		-	
BRAND	TYPE		MODEL		COLOR		LENS		MOUNTING		ENDCAP
STANDARD LENGTHS:		<input type="checkbox"/> 8'	QUANTITY:	<input type="text"/>	<input type="checkbox"/> 16'		QUANTITY:	<input type="text"/>			
CUSTOM LENGTHS (INCHES):			<input type="text"/>	<input type="text"/>	<input type="text"/>	<input type="text"/>	<input type="text"/>				

