

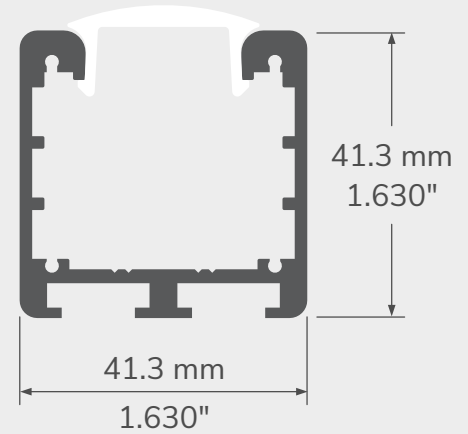

**TECHNICAL DRAWING**







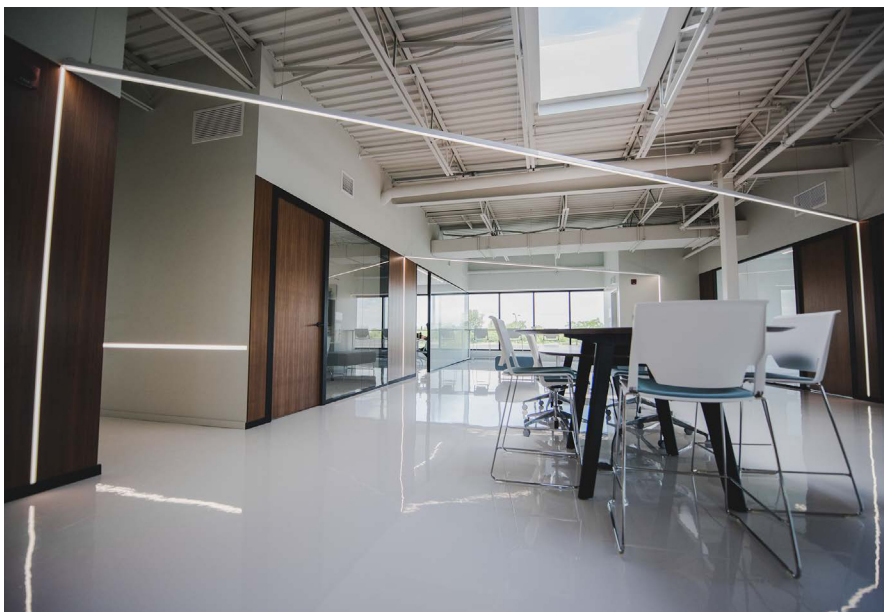





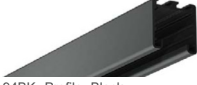





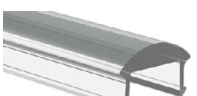



**A STURDY ALUMINUM PROFILE**

The 94 profile with its twin mounting channels allows for a wide range of installation options. Whether on swivel arms, on a surface, or suspended, it can be built in complex spatial configurations using corner joiners. Its rugged build in 6063-T5 aluminum alloy will withstand abuse in demanding applications and extreme weather, all of it with an understated elegance.



**FEATURES**

- The ALCOA 6063-T5 aluminum alloy increases heat dissipation, for an extended lifetime of the LED source, and is suitable for outdoor installation.
- Custom length by sections of 2 to 240 inches (6m).
- 3 position slots for the LED heat sink insert for setting the needed beam angle.
- Accepts multiple or oversized LED sources on a 33mm (1.25in) wide area, for extra power. Has application guides for 10mm (3/8-inch) wide LED engines.
- Designed to give a uniform light without hot spots.
- Its mounting channels make it compatible with a wide range of installation accessories.

PROFILE	LENSES	MOUNTING HARDWARE	CANOPY	OPTION	LENGTH
 <p>94 - Profile, Alu</p>  <p>94BK - Profile, Black</p>  <p>94WH - Profile, White</p>  <p>94CS - 94 Profile, custom color</p>	 <p>CL - Clear lens</p>  <p>OX - Optiflex lens</p>  <p>OP - Opal Lens</p>  <p>PR - Prime Lens</p>  <p>FO - Focus lens</p>  <p>NO - No lens</p>	 <p>CLIP - Clip-in Bracket</p>  <p>Surface 2-side bracket S20 - Alu S21 - Black S22 - White</p>  <p>Surface 1-side bracket S10 - Alu S11 - Black S12 - White</p>  <p>Surface 90-deg. bracket S30 - Alu S31 - Black S32 - White</p>  <p>Swivel wall bracket SW0 - Alu SW1 - Black SW2 - White</p>  <p>Swivel sign arm, 6" offset SA60 - Alu SA61 - Black SA62 - White</p>  <p>Swivel sign arm, 18" offset SA180 - Alu SA181 - Black SA182 - White</p>  <p>Type B dbl, chann. susp. kit with 15ft. aircraft cable SUS0 - Alu SUS1 - Black SUS2 - White</p>	<p>NOTE: Only available with SUS bracket (suspension)</p>  <p>Remote driver canopy plate CR0 - Alu CR1 - Black CR2 - White</p>  <p>Integrated driver in canopy C10 - Alu C11 - Black C12 - White</p>  <p>Integrated driver &amp; suspension kit CIK0 - Alu CIK1 - Black CIK2 - White</p>	 <p>HER - High efficiency reflector</p>  <p>NO - No option</p>	<p>Custom length by sections of 6 to 240 inches (6m).</p>
<p>RAL NUMBER</p>  <p>94 corner 90°, 6x6" <i>Joiners to be ordered separately</i></p> <p>CH900-94 corner 90°, 6x6", alu</p> <p>CH901-94 corner 90°, 6x6", black</p> <p>CH902-94 corner 90°, 6x6", white</p>  <p>94 corner 135°, 6x6" <i>Joiners to be ordered separately</i></p> <p>CH1350-94 corner 135°, 6x6", alu</p>  <p>Joiners</p> <p>JS - Type B straight joiner</p>	<p>QTY</p> <p>QTY</p> <p>QTY</p> <p>QTY</p>				

