

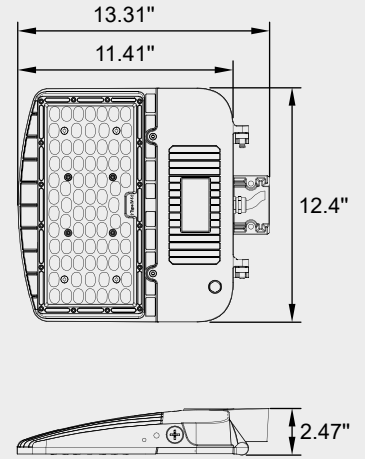

TECHNICAL DRAWING



DESCRIPTION

This 150-watt outdoor LED floodlight available in black or bronze color stands as an exemplary solution for potent outdoor illumination, tailored to meet diverse lighting needs in industrial and commercial environments. Engineered for versatility, it features an adjustable light output, allowing selection among 70W, 100W, or 150W settings. Ideal for lighting expansive areas such as parking garages, arenas, and stadiums, the floodlight also offers selectable correlated color temperature (CCT) functionality. Users can choose from 3000K for a warm ambiance, 4000K for a brighter light, or 5000K for maximum brightness. With a remarkable lifespan of 50,000 hours, the floodlight assures long-lasting, reliable performance, establishing itself as a formidable choice for comprehensive outdoor lighting projects.

FEATURES

- Slim & Compact Area Lighter with Polycarbonate Lens.
- Pressure Die Cast Aluminum body to ensure better Thermal Management.
- Four different brackets for installation: Pole, Trunnion, "U" shape and Knuckle bracket
- CCT and Multi-Watt selector
- Compatible with 0-10V Dimming
- Suitable for use in wet locations (IP65 protection)
- 120-347V LED Auto-Sensing driver with 10KV Surge Protection Device.
- 50 000 hours lifetime
- 5 Years warranty

SPECIFICATION

Model	Color	Color Temp. (K)	Wattage (W)	Lumen	Input Voltage (V)	Operating Temperature (°C)
LCFLD70-100-150W-MK-UV-BK	Black	CCT (3000-4000-5000)	70-100-150	9100-13000-19500	120-347	-40 to 45
LCFLD70-100-150W-MK-UV-BR	Bronze					

ACCESSORIES

This floodlight can be installed using four distinct brackets, each sold separately: the pole bracket, trunnion bracket, U-shape bracket, and knuckle bracket.



Pole
LCFLD-BRACKET-P



Trunnion
LCFLD-BRACKET-T



U-Shape
LCFLD-BRACKET-U



Knuckle
LCFLD-BRACKET-K

POLAR CANDELA

