

DESCRIPTION

- TYPE: Back-Lit Mirror
- SHAPE: Rectangle
- Dimmable with any standard MLV / TRIAC dimmer wall switch
- CRI 90+
- IP Rating: 44
- 120V wiring
- Approx. 120,000 Hours Lifetime
- Complete UL and cUL Certification
- Hangs horizontally or vertically

AVAILABLE LED COLORS (Kelvin)

3000K



6000K



MODELS AND SPECIFICATIONS

MODELS	PRODUCT NUMBERS	DIMENSIONS	LUMENS	WATTS	WEIGHT
Paris 48 X 28	LCMIR-PAR-BL-4828-30/60K	48"W x 28"H x 1.6"D	4960/4970lm	45W	31lbs
Paris 40 X 35	LCMIR-PAR-BL-4035-30/60K	40"W x 35"H x 1.6"D	4140/4250lm	35W	32lbs
Paris 96 X 28	LCMIR-PAR-BL-9628-30/60K	96"W x 28"H x 1.6"D	8930/9180lm	76W	60lbs
Paris 80 X 35	LCMIR-PAR-BL-8035-30/60K	80"W x 35"H x 1.6"D	7620/7830lm	65W	62lbs
Paris 100 X 45	LCMIR-PAR-BL-10045-30/60K	100"W x 45"H x 1.6"D	9920/9940lm	90W	90lbs



COLOR RENDERING INDEX

The color rendering index (CRI) of a light source is a quantitative measure of its ability to reproduce the colors of various objects faithfully in comparison with an ideal or natural light source.

In general terms, CRI is a measure of a light source's ability to show object colors "realistically" or "naturally".

We only use LED CRI 90+.

COLOR TEMPERATURE

We offer 2 different light colors for our mirrors.

6000K: Pure white color light. It is the most popular color for makeup application and hairstyling.

In addition, the 6000K is 15% brighter than the 3000K light color. 85% of our customers choose the 6000K light color.

3000K: Warm white color light, the light is a little yellow.



PARIS 48 X 28

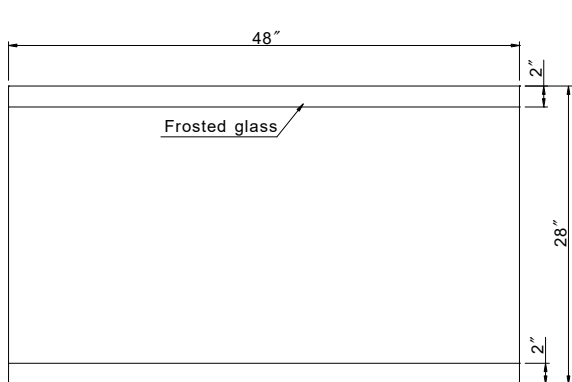

FRONT VIEW

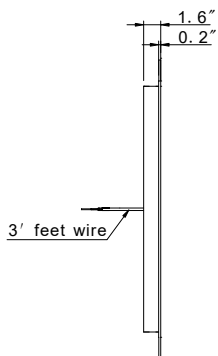

LEFT SIDE

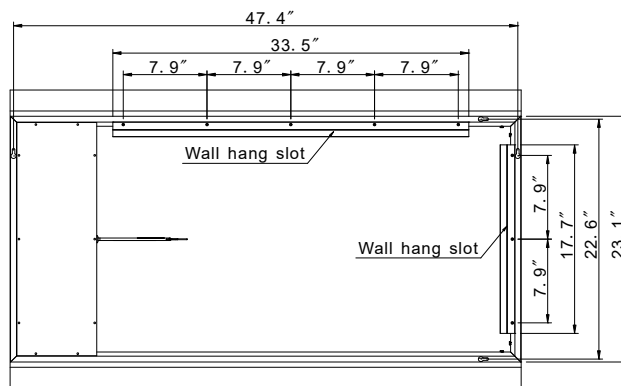

REAR VIEW



TOP VIEW

PARIS 40 X 35

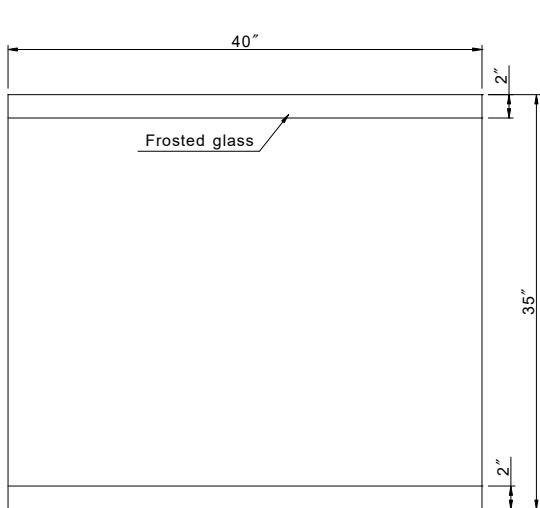

FRONT VIEW

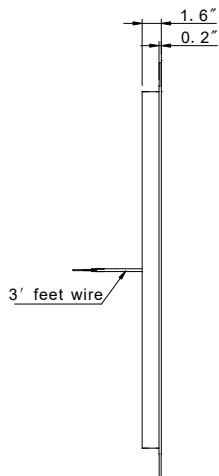

LEFT SIDE

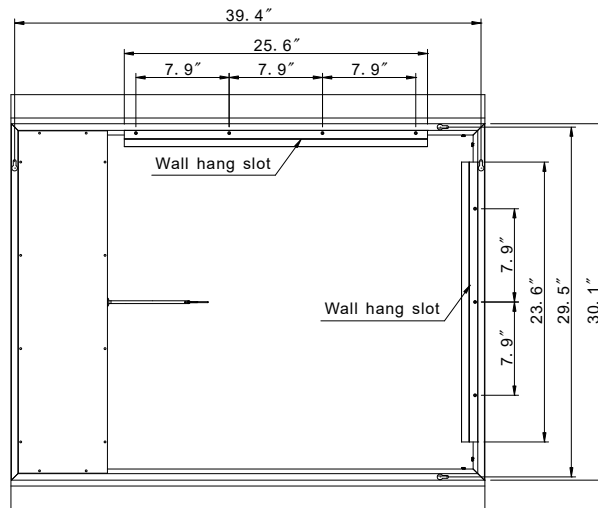

REAR VIEW



TOP VIEW

PARIS 96 X 28

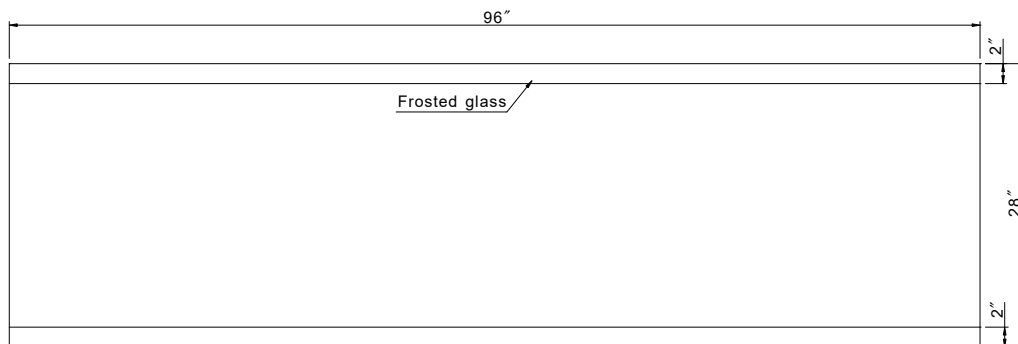

FRONT VIEW

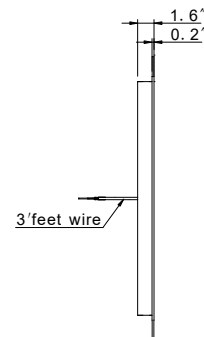

LEFT SIDE

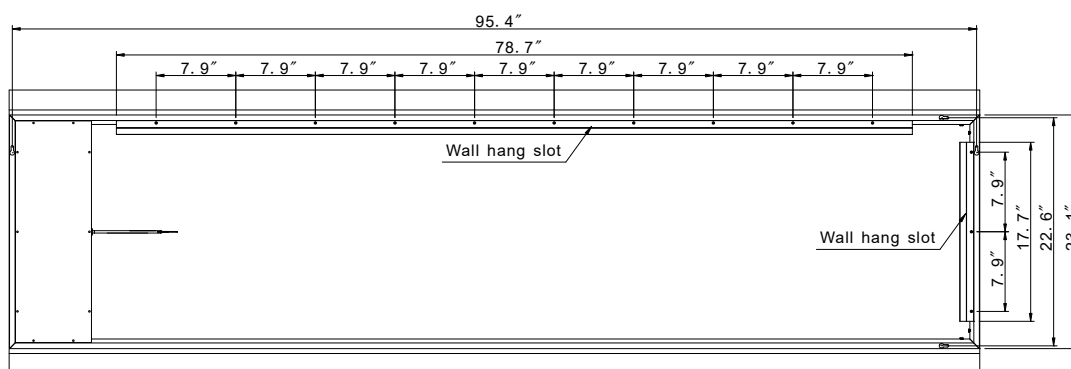

REAR VIEW

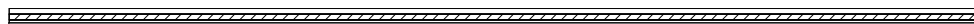

TOP VIEW

PARIS 80 X 35

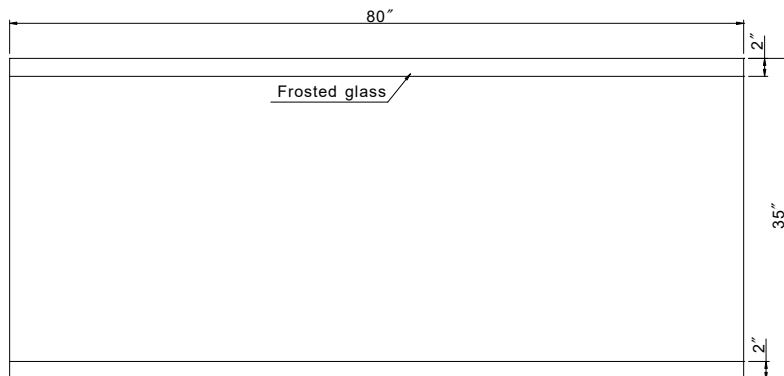

FRONT VIEW

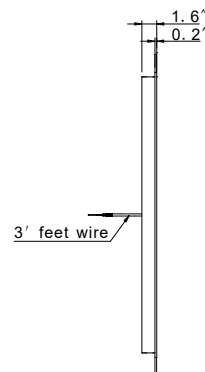

LEFT SIDE

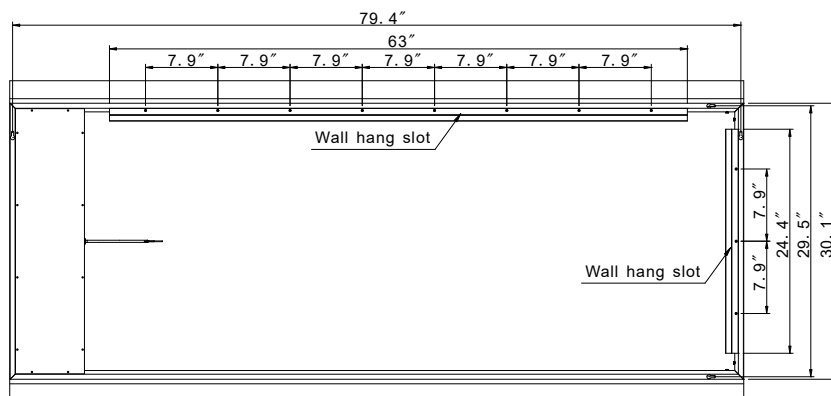

REAR VIEW

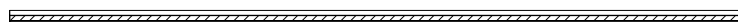

TOP VIEW

PARIS 100 X 45

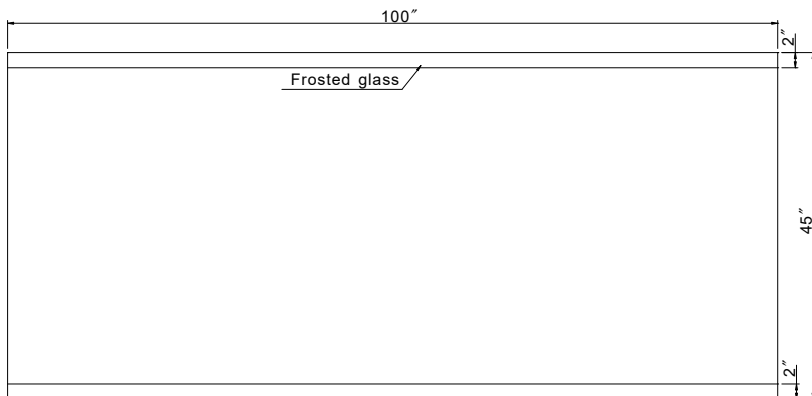

FRONT VIEW

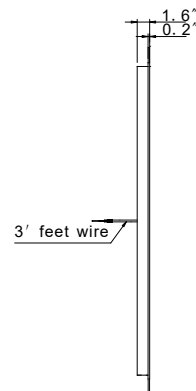

LEFT SIDE

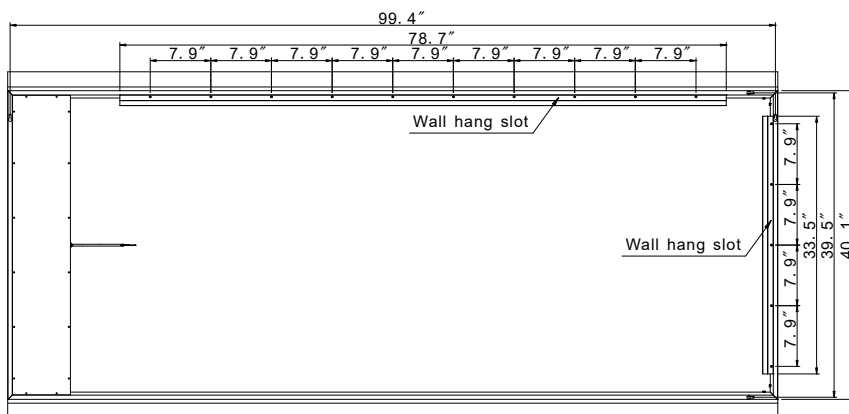

REAR VIEW

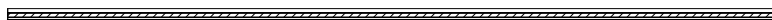

TOP VIEW

INSTALLATION & AFTER CARE INSTRUCTIONS

Installation:

- All our LED mirrors have been independently tested for compliance with electrical equipment (safety) regulations.
- All illuminated and backlit mirrors are IP44 rated.
- Illuminated mirrors have been designed and independently tested for compliance to electrical equipment (safety) regulations, and are UL Certified.
- LEDs have a life expectancy of 120,000 hours of continuous use. All LED light fittings are replaceable and are available through our customer service.
- **IMPORTANT:** Always switch off the electrical supply at the mains during installation and maintenance.
- It is recommended that fuse is withdrawn or circuit breaker switched off before installation begins.
- Fitting in Bathrooms is subject to all regulations. It is not suitable for product installations in Saunas, Steam Rooms, or shower cubicles and it is recommended for permanent installation.

Care Safety:

- Wear suitable eye wear protection when drilling. Use caution when using power tools near water, beware of hidden cables or pipes.
- Take care if drilling on tiled surfaces in case the drill slips. A piece of masking tape applied to wall before marking out fixing holes will stop drill from moving.

Cleaning & Maintenance:

- It is recommended that the unit is cleaned with a soft, dry, non-abrasive cloth when turned off.
- Never use cleaning agents or abrasive material on any type of surface finish.
- Do not strike glass components with hard or pointed items.
- Do not place very hot or cold items against or close proximity to glass surfaces.

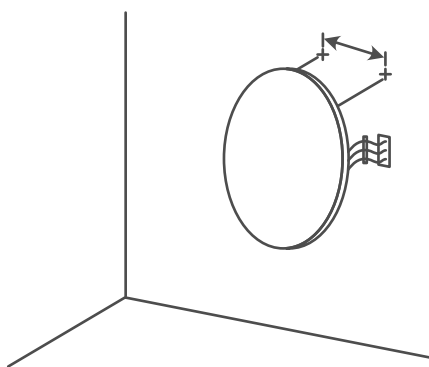

120V DIMMABLE LED DRIVER INCLUDED

- 1-Decide on wall positional placement.
- 2-Prepare & install wall hooks measured to distance between mirror's
- 3-Match & attach 3 electrical wires from mirror to home electrical wires: Live to Live, Ground to Ground, Neutral to Neutral.
- 4-Hang and affix to wall.