



DESCRIPTION

This 4-foot linear suspended luminaire, available in white, black, and silver finishes, combines aesthetics and performance for a versatile LED lighting solution. Featuring a multi-watt selector, it allows the adjustment between three different wattage settings, varying depending on the model. Its beam angle of 90° ensures efficient and uniform lighting. The luminaire offers exceptional longevity with a lifespan of 50,000 hours, ensuring long-term reliability and durability. Its sleek, modern design integrates seamlessly into various environments. Another key feature is its CCT color temperature, which can be selected among 3500K, 4000K, and 5000K, providing the flexibility to adapt the lighting ambiance as needed.

FEATURES

- Multi wattage and 3CCT
- Robust Aluminium Casing
- Available in White, Black or Silver color
- Various Suspension-Mount Installations
- Up to 8 fixtures can be linked together
- Compatible with 0-10V Dimming
- Suitable for use in damp locations (IP44 protection)
- 90° Beam angle
- 50 000 hours lifetime
- 5 years warranty

SPECIFICATION

Model	Color	Wattage (W)	Lumen	Color Temp. (K)	Input Voltage (V)	Operating Temperature (°C)
LCSUSP-D-4FT-WH-40W-CCT	White	24-32-40	2640-3520-4400	CCT (3500-4000-5000)	120-347	-20 to 45
LCSUSP-D-4FT-BK-40W-CCT	Black					
LCSUSP-D-4FT-SL-40W-CCT	Silver					
LCSUSP-D-4FT-WH-50W-CCT	White	30-40-50	3300-4400-5500			
LCSUSP-D-4FT-BK-50W-CCT	Black					
LCSUSP-D-4FT-SL-50W-CCT	Silver					

TECHNICAL DRAWING

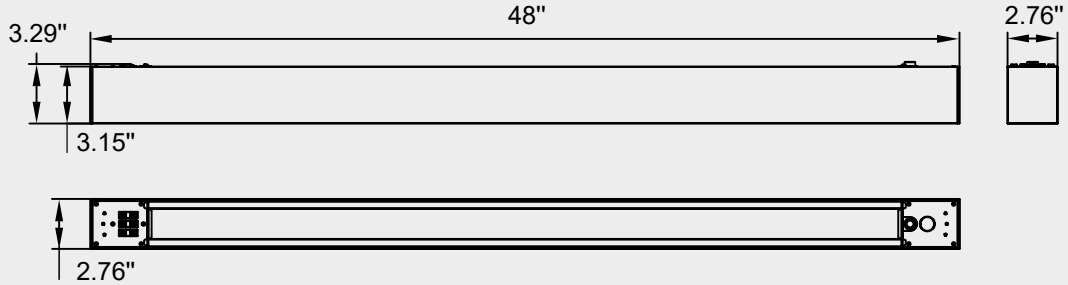

ROPE SUSPENSION INSTALLATION

1. Drill a hole of 5.0mm in diameter at the location required for installation. Then install the plastic anchor to the hole with hammer.

2. Insert PA4*30 Screws into the screw holder and then drill into the plastic anchor.

- Screw Holder
- PA4*30 Screw
- Steel wire rope holder
- Steel wire rope

3. Lock the steel wire rope pedestal to the ends plates with PM4*8 screws.

4. Press down the inner hole of the steel wire rope pedestal, let the steel wire rope go through the hole.

5. Connect L, N, GND, DIM+ and DIM- of AC input wire to L, N, GND, DIM+ and DIM- respectively of AC terminal.

6. Press the to pend of the steel wire rope pedestal to adjust the steel wire rope, and then finish the installation.

CANOPY SUSPENSION INSTALLATION

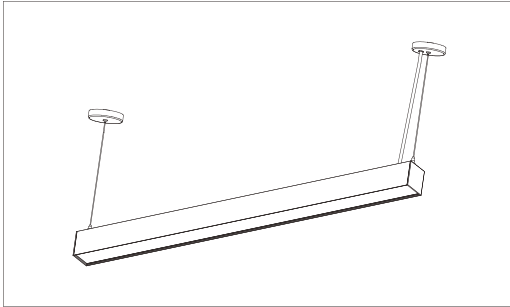

1. Drill a hole of 5.0mm in diameter as shown in the figure at the location required for installation. Then hammer the plastic anchor into the hole.

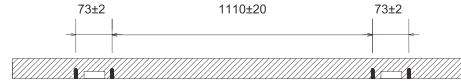

2. Insert PA4*35 screws into the M type mounting bracket and then drill into the plastic anchor.

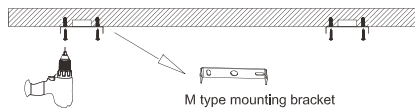

3. Lock the steel wire rope pedestal to the ends plates with PM4*8 Screws.

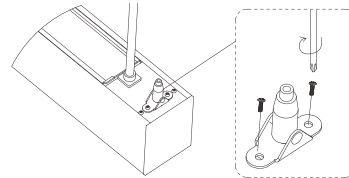

4. Press down the inner hole of the steel wire rope pedestal, let the steel wire rope go through the hole.

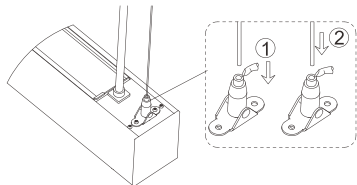

5. Insert the steel wire rope holder into the middle hole of the canopy and tighten the steel wire rope holder with hex nut; Clip the cable protective cover into the AC line hole of the canopy.

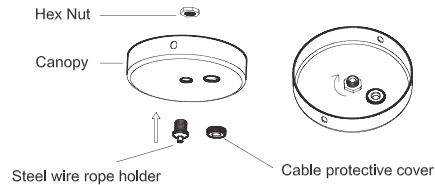

6. Press the steel wire rope holder as shown in the figure, and then insert the stainless steel wire into the inner hole of the steel wire rope holder. The mounting height of the lamp could be adjusted by this steel wire rope holder.

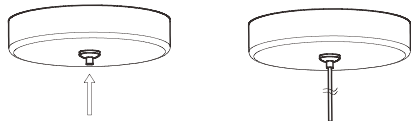

7. Insert the AC input cable through the cable protective cover and connect it with the AC line by the corresponding connection wire with L,N,GND.

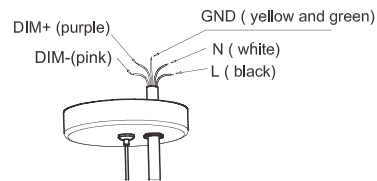

8. Adjust the length of the AC input cable, align the side hole of the canopy and the M mounting bracket as shown in the figure, then tighten the screw.

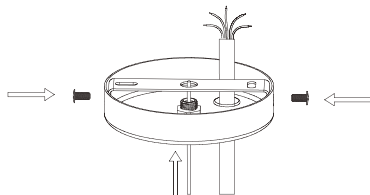

9. The installation is completed.

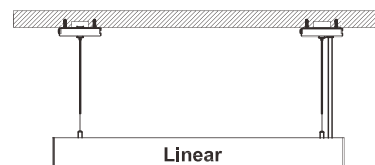

LINKABLE INSTALLATION

1. Measure the ceiling, make down the position for lineae1, install the first Linear Light to the ceiling as instruction of A Rope Suspension Installation.

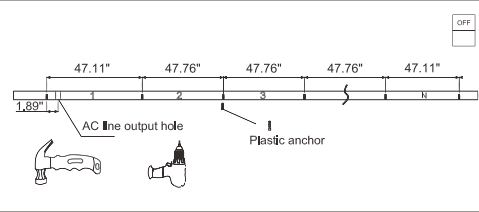

2. Install Linear 1, then connect AC line; remove one end cap as show on (2-b).

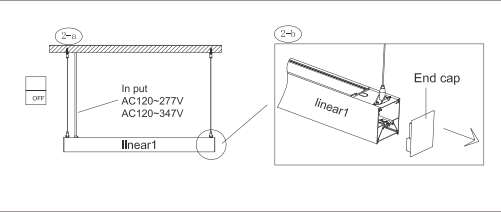

2-c. Lift up the up-light module as the picture shows.

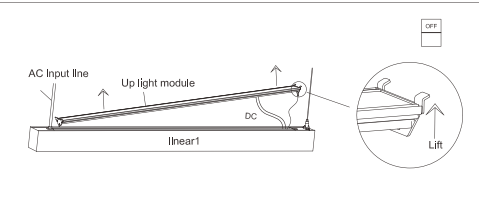

2-d. Insert the linkable bracket into the Linear 1, connect with buckle inside the Linear 1, take out the inside linkable wire. (Five color)

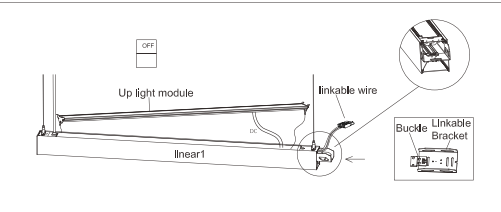

3. Insert the Linear Light as Step 2 and adjust the steel wire rope in the same height. Then Move out two end caps of Linear 2, lift up the up light module, disconnect the AC wire. Keep the female plug to the side ends.

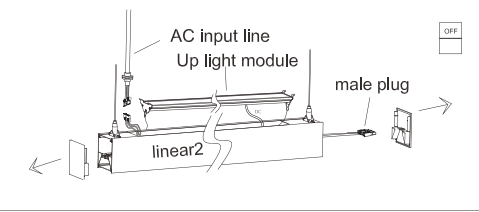

4. Connect the male plug of Linear 1 and female plug of Linear 2, insert the bracket to the Linear 2 make them seamless linkable together.

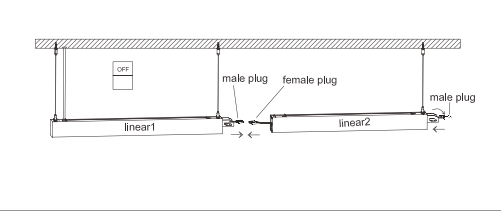

5. Check the status after linked make sure no any gap between two linears.

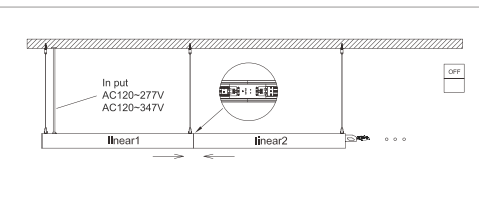

6. Make sure the male and female plugs have been connected well, press down the up light module, put it back to the top of Linear 1 and Linear 2.

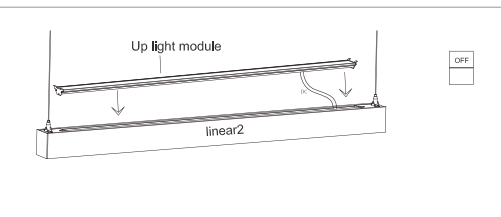

7. Install the Linear Light 3,4,5,6 and 7 as above method, keep one main input cord on one side for wiring and grounding adjust the steel wire rope in the same height. Then finish the installation.

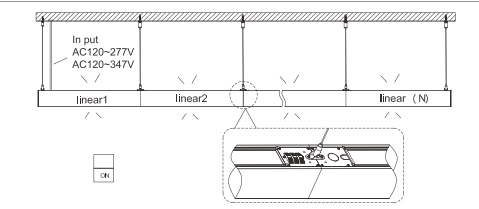

WARNING

- ⚠ Risk of fire or electric shock. Fixture installation requires knowledge of luminaires electrical systems. If not qualified, DO NOT attempt installation. Contact a qualified electrician.
- ⚠ Risk of fire or electric shock. Suitable for wet locations. Always turn off the power supply before installation.
- ⚠ Risk of fire or electric shock. Suitable for non-insulated surface and frame. DO NOT cover fixture with insulation liner or similar material.
- ⚠ DO NOT install fixture on unstable, loose or easily breakable surface.
- ⚠ DO NOT exert force on the surface of the fixture.

NOTE

- 1.The installation and maintenance must be completed by electricians or professionals.
- 2.Please cut off the power before installation and maintenance.
- 3.The thermally insulating material is not allowed to cover the fixture.
- 4.Please keep away from the corrosive substance, and keep the fixture dry and clean.
- 5.Working temperature: -4°F~113°F, storage temperature: -22°F~140°F.