

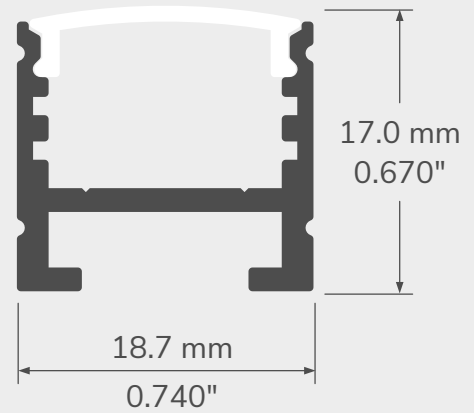

**TECHNICAL DRAWING**







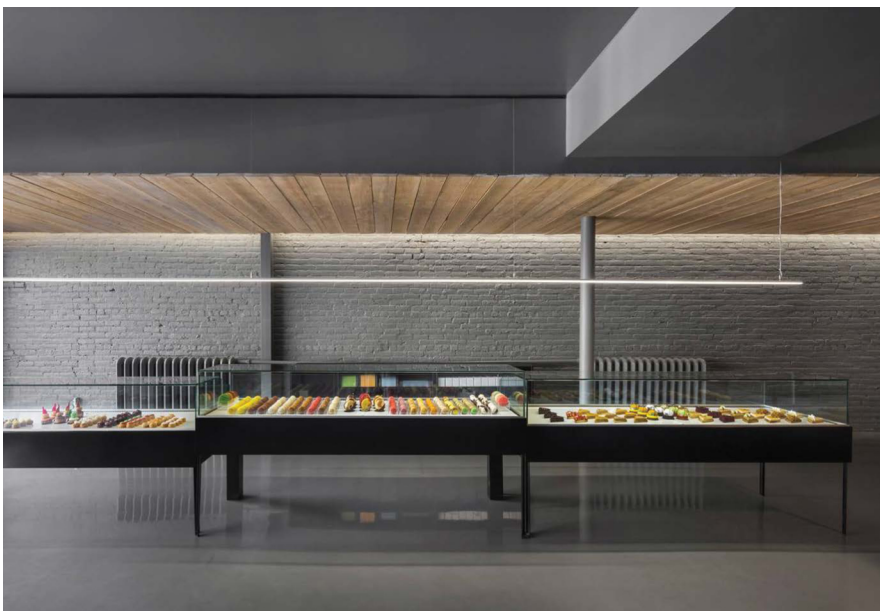





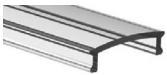

**A SMALL PROFILE AMONG THE BIG BOYS**

In addition to offering even lighting, the 14 allows beam adjustment as well as a considerably larger choice of installation options. This profile also offers a wide variety of installation, from fixed to suspended mounting.

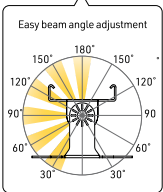

**FEATURES**

- The support rail offers the largest range of installation and assembly.
- Designed to give a uniform light without hot spots with an opal or prime lens.
- Custom length by sections of 2 to 240 inches (6m).
- Application guide for 10mm (3/8-inch) LED engine or less.
- Made of ALCOA 6063-T5 aluminum alloy increasing heat dissipation.
- Its use increases the lifetime of your LED engine.
- Compatible with multiple installation accessories (over 40 options).
- Designed to meet North American woodworking standards.

PROFILE	LENSES	MOUNTING HARDWARE	LENGTH
 <p>14 - Profile, alu</p>	 <p>CL - Clearlens</p>	 <p>FL - Flat bracket</p>	<p>Custom length by sections of 2 to 240 inches (6m).</p>
 <p>14BK - Profile, black</p>	 <p>PR - Prime lens</p>	 <p>45 - 45° Corner bracket</p>	
 <p>14WH - Profile, white</p>	 <p>BK - Black lens</p>	 <p>SW - Swivel bracket 180°</p>	
 <p>14CS - Profile, custom color</p>	 <p>FO - Focus lens</p>	 <p>Easy beam angle adjustment</p> <p>180° 150° 150° 120° 120° 90° 90° 60° 60° 30° 30°</p>	
	 <p>OP3D - Square 3D, Opal</p>		

