

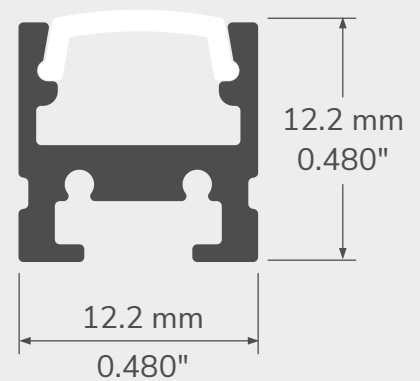

**TECHNICAL DRAWING**











**ONE OF THE SMALLEST ON THE MARKET**

Guaranteed to be discreet! The no.44 profile is reduced to a minimum with its size of less than half an inch, while accepting a good range of LED strips up to 8mm wide.

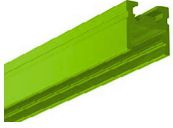

**FEATURES**

- Ultra-compact aluminum profile —12.2mm wide by 12.2mm high (0.5 x 0.5in).
- Custom length by sections of 2 to 240 inches (6m).
- Made of ALCOA 6063-T5 aluminum alloy increasing heat dissipation.
- Its use increases the lifetime of your LED engine.
- Compatible with multiple installation accessories.
- Designed to meet North American woodworking standards.
- Conforms to UL STD. 2108 for closet usage.

PROFILE	LENSES	MOUNTING HARDWARE	LENGTH
 <p>44 - Profile, alu</p>	 <p>CL - Clear lens</p>	 <p>FL - Flat bracket</p>	<p>Custom length by sections of 2 to 240 inches (6m).</p>
 <p>44BK - Profile, black</p>	 <p>OX - Optiflex lens</p>		
 <p>44CS - Profile, customcolor</p>	 <p>OP - Opal lens</p>		
	 <p>SIL - SiLens</p>		
	 <p>BK - Black lens</p>		