

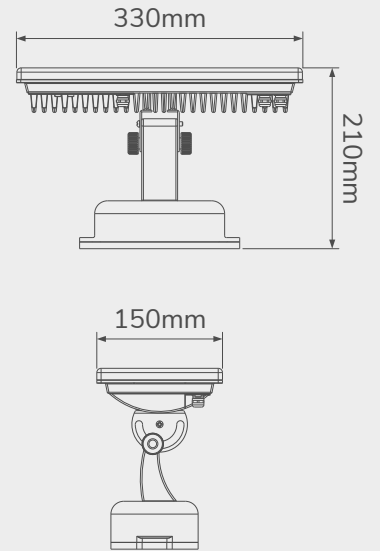

TECHNICAL DRAWING



SPECIFICATIONS

- | | | | |
|------------------------|-----------------|------------------------|---------------------------------------|
| • Input voltage : | 120~240V AC | • Working mode : | Independant/DMX/ Master/Slave Mode |
| • Rated power : | 40W | • IP Grade : | IP65 |
| • LED quantity : | 36 | • Environment : | Suitable for damp location |
| • Working temp.: | -20°C ~+40°C | • Certifications : | cETLus, CE |
| • Available length : | 13 inches | • Color Temperatures : | RGB |
| • Rotary angle : | 150° (vertical) | | |
| • Beam angle : | 10°/20°/45° | | |
| • Materials of Shell : | Aluminium alloy | | |

MODEL CONFIGURATION TABLE

| Model No. | Size | LED color | Power consumption | *Beam Angle | Weight |
|------------------|------------------|-----------|-------------------|-------------|----------|
| LCWW6-40W-XX-RGB | L330xW150xH210mm | RGB | 40W | 10°/25°/45° | 4.3kg±5% |

*The XX in the product code refers to the beam angle.

WORKING MODE

Independent Mode: Choose the build-in programs via the buttons on the back of the head.

DMX Mode: International standard DMX512 signal.

Master/Slave Mode: Auto online and synchro working.

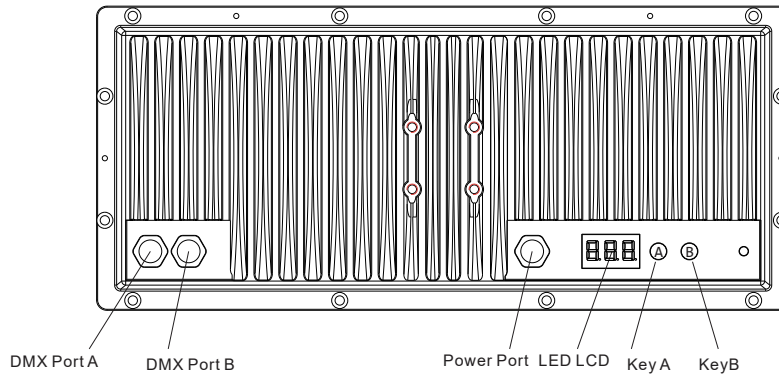

FUNCTION & SETUP

- Independent mode:

After pressing **A** four times (the first three times is the setup on DMX address) or **B** directly, light enter into independent mode; the digital LEDs show **PXY**, press **A** once, active digital LEDs move backward, you can choose function via **X** and parameter via **Y**; Press **B**, the corresponding flash digital LED increases one bit (range:1~9).

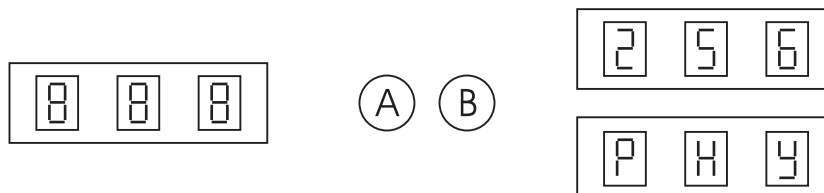

X refers to functions (the value between 1 to b), Y refers to value of speed and gray degree for the functions (the value between 1 to 9).When pressing button,please wait for about 10 sec,then you can exit the mode of adjustment function,the digital LED stop flashing and data recorded.

Function and parameter sheet:

| X value | Y value |
|-----------------|-----------------------|
| 1-static red | 1~9 class gray degree |
| 2-static green | 1~9 class gray degree |
| 3-static yellow | 1~9 class gray degree |
| 4-static blue | 1~9 class gray degree |
| 5-static purple | 1~9 class gray degree |
| 6-static cyan | 1~9 class gray degree |

| X value | Y value |
|-----------------------|-----------------------|
| 7-staic white | 1~9 class gray degree |
| 8-multicolor changing | 1~9 class speed |
| 9-single fading | 1~9 class speed |
| A-multicolor fading | 1~9 class speed |
| B-multicolor flashing | 1~9 class speed |
| C-autorun | 1~9 times circle |

- DMX mode:

- DMX Addressing

When the digital LED is not flashing,press A,digital LED begin to flash,press A once,active digital LEDs moves backward,you can start to edit the second digital LED;Press B, the corresponding flash digital LED increase one bit (the values between 1 to 9).

- DMX Channel instruction-3 Channels available as sheet:

| CHANNEL 1 | | CHANNEL 2 | | CHANNEL 3 | |
|-----------|-------------------|-----------|---------------------|-----------|--------------------|
| Data | Function | Data | Function | Data | Function |
| 0~255 | Brightness of Red | 0~255 | Brightness of Green | 0~255 | Brightness of Blue |

***Enter or quit DMX mode automatically once detecting valid signal!

- Master/Slave Mode:

Choose any one light as the master for attaining auto online function,the operations are as below: firstly, set the address of master as 001, others are set as slave (address can be any one except 001); Change function of the master (001) light, then all lights will work synchronously;

PHOTOMETRIC PARAMETERS

- Cadela distribution

Beam angle: 10°

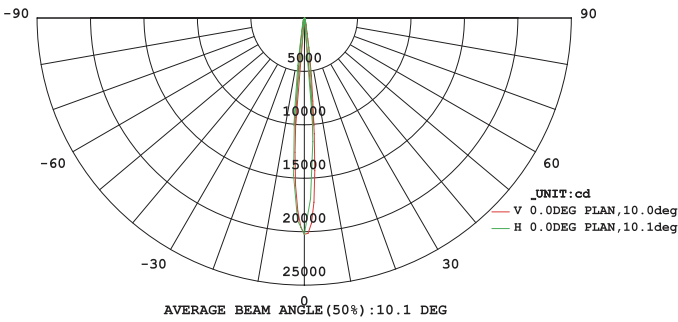

RGB

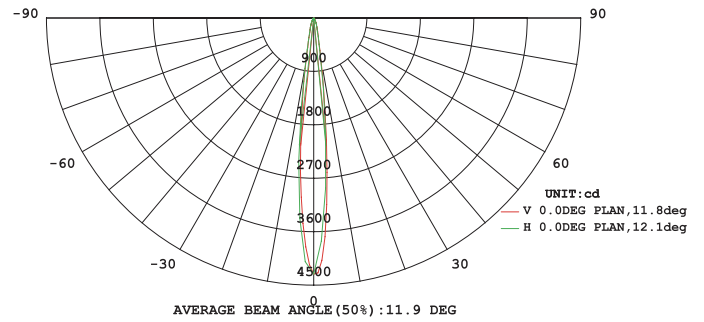

Red

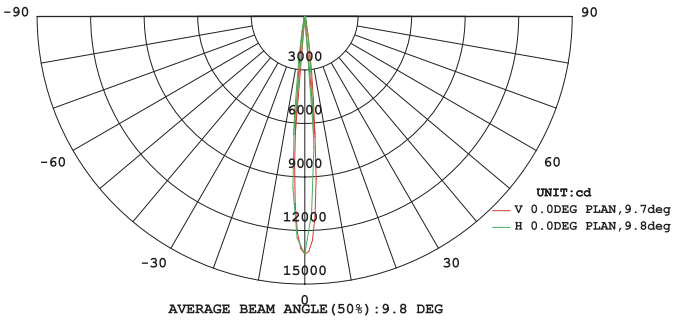

Green

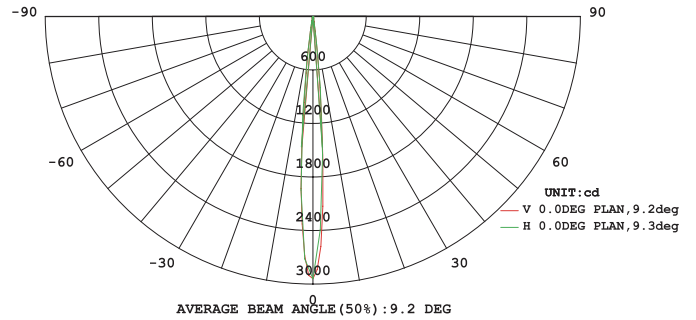

Blue

• Illuminance at a distance

Beam angle: 10°

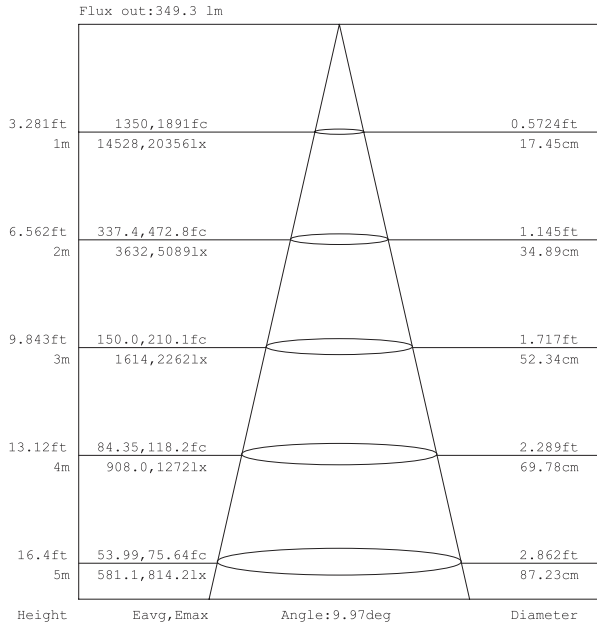

Note: The Curves indicate the illuminated area and the average illumination when the luminaire is at different distance.

RGB

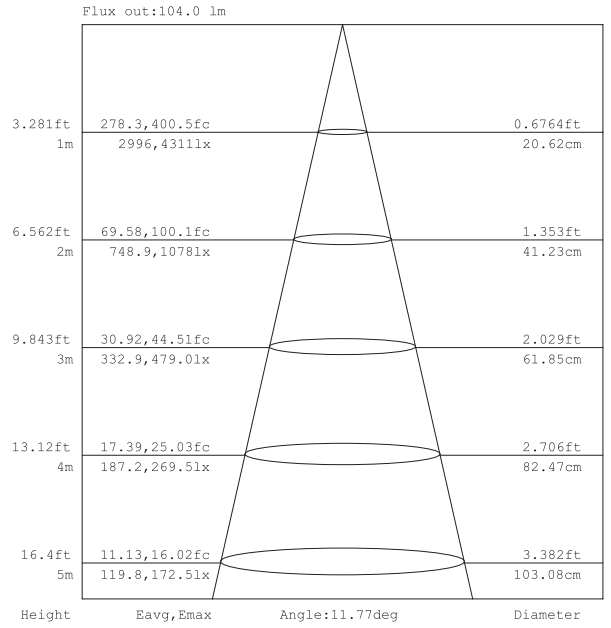

Note: The Curves indicate the illuminated area and the average illumination when the luminaire is at different distance.

Red

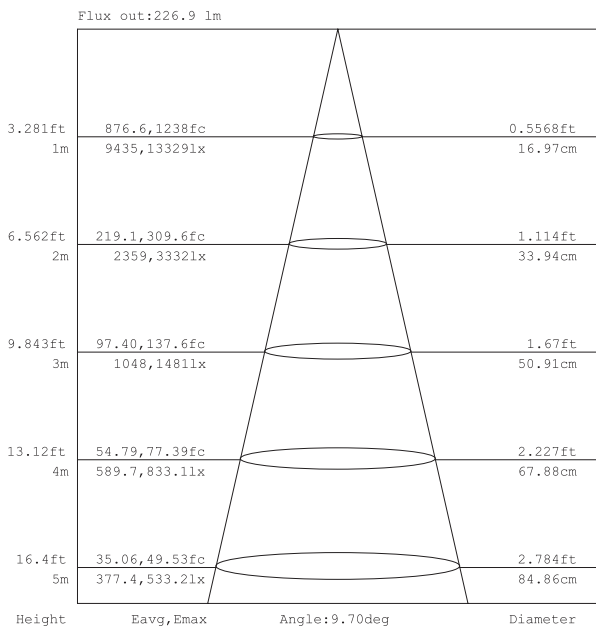

Note: The Curves indicate the illuminated area and the average illumination when the luminaire is at different distance.

Green

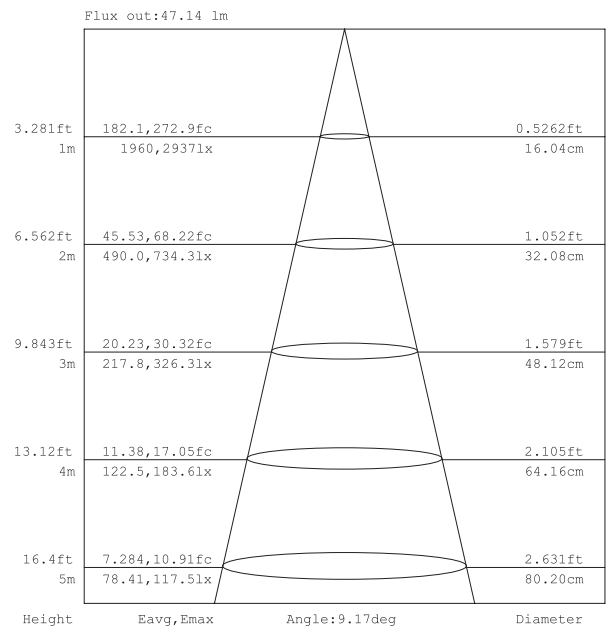

Note: The Curves indicate the illuminated area and the average illumination when the luminaire is at different distance.

Blue

INSTALLATION

Attach the brackets using M6 tapping screws, with the mounting dimensions as follows:

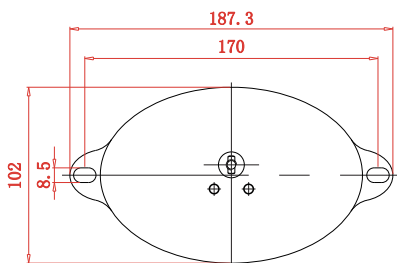

CONNECTION

Signal max connection is 100m, every 100m or 60pcs fixtures needs a signal amplifier.

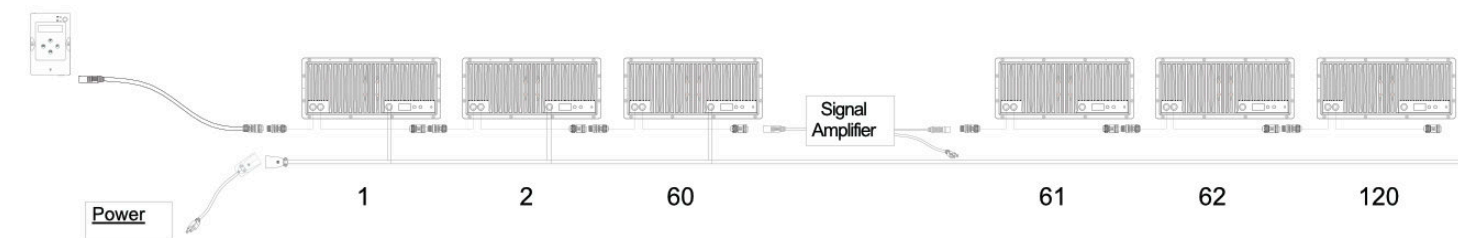

WATERPROOF TREATMENT

The signal output connector XLR-3 of the last fixture of each series must be sealed with a 20mm thermal shrinking tube (-1), blow and shrink it with a hair driers; thence wrapped with waterproof tape (auto-adhesive, please refer to below instruction for operation) on both side; Blow the second 25mm shrink tube (-2) at last so as to protect waterproof tape under sunshine and guarantee the waterproof validity.

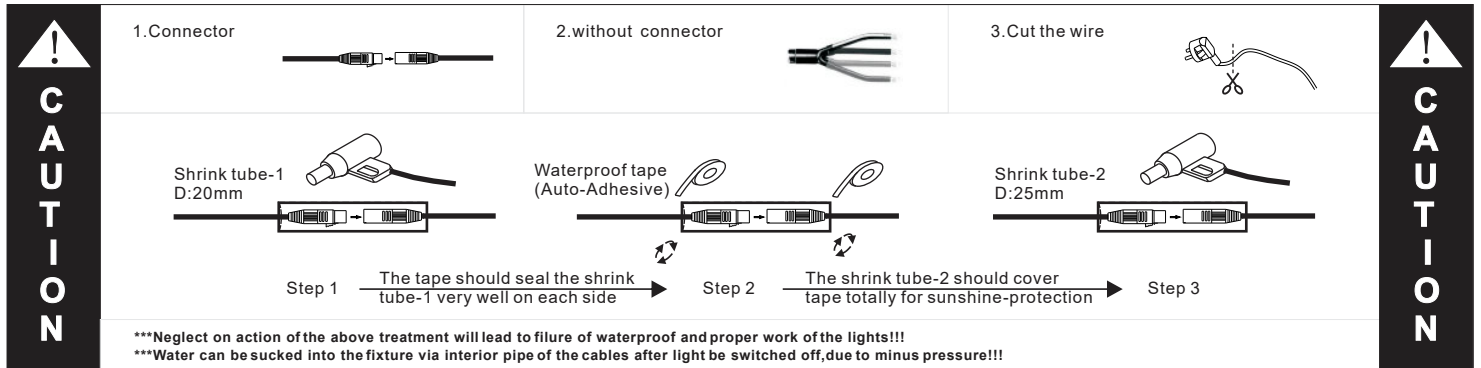

*** Power connector should be treated in the same way if available!!!

*** IP68 connector does not require above treatment, but you connect a threaded twist quite well to prevent operational errors lead to joint water

Caution.

1. Do not connect to power while the product remains in its packaging.
2. Avoid covering the fixture while in use.
3. Do not use this product in confined spaces.
4. If the product seems damaged, refrain from using it.

Warning!

- ! Failure to follow the above precautions will compromise the waterproofing and proper functioning of the lights.
- ! Ensure proper ground connections to prevent electric shock, especially with the metal housing.

The instructions provided are subject to updates or improvements without prior notice.
Please consult our staff for more details.